

# LED DISPLAYS

| NTE Type Number | Description   | Diagram Number | Color  | Digit Description | Maximum Forward Current Per Segment (mA)                                  | Maximum Reverse Voltage Per Segment (Volts) | Maximum Power Dissipation (mW) |
|-----------------|---|----------------|--------|-------------------|---|---|--------------------------------|
|                 |   |                |        |                   | I <sub>F</sub>  | V <sub>R</sub>                              | P <sub>T</sub>                 |
| 3050            | 0.270 Inch, Seven Segment, Common Anode, LHDP                           | 153            | Red    |                   | 30  | 10  | 750                            |
| 3051            | 0.270 Inch, Polarity and Overflow, Common Anode                         | 154            | Red    |                   | 30  | 10  | 480                            |
| 3052            | 0.300 Inch, Seven Segment, Common Anode, RHDP                           | 155            | Red    |                   | 30  | 5   | 700                            |
| 3053            |   | 155            | Orange |                   | 20  | 3   | 400                            |
| 3054            |   | 155            | Green  |                   | 20  | 3   | 400                            |
| 3055            |   | 155            | Yellow |                   | 20  | 3   | 400                            |
| 3056            | 0.300 Inch, Seven Segment, Common Cathode, RHDP                         | 155            | Red    |                   | 30  | 6   | 480                            |
| 3057            |   | 155            | Red    |                   | 25  | 3   | 700                            |
| 3058            |   | 155            | Orange |                   | 20  | 6   | 600                            |
| 3059            |   | 155            | Green  |                   | 20  | 6   | 480                            |
| 3060            | 155   | Yellow         | 20     | 6                 | 600   |   |                                |
| 3061            | 0.300 Inch, Seven Segment, Common Anode, LHDP                           | 156            | Red    |                   | 30  | 6   | 480                            |
| 3062            |   | 156            | Orange |                   | 20  | 6   | 600                            |
| 3063            |   | 156            | Green  |                   | 20  | 6   | 480                            |
| 3064            |   | 156            | Yellow |                   | 20  | 6   | 600                            |
| 3065            | 0.300 Inch, Polarity and Overflow, Common Anode                         | 157            | Red    |                   | 30  | 6   | 300                            |
| 3068            | 0.400 Inch, Seven Segment, Common Anode, RHDP                           | 158            | Red    |                   | 30  | 6   | 480                            |
| 3069            | 0.400 Inch, Seven Segment, Common Cathode, RHDP                         | 158            | Red    |                   | 30  | 6   | 480                            |
| 3070            | 0.400 Inch, Seven Segment, Common Anode, RHDP                           | 158            | Orange |                   | 30  | 6   | 600                            |
| 3071            | 0.400 Inch, Seven Segment, Common Cathode, RHDP                         | 158            | Orange |                   | 30  | 6   | 600                            |
| 3074            | 0.560 Inch, 2 Digit, Common Anode, RHDP                                 | 159            | Red    |                   | 30  | 6   | 960                            |
| 3075            | 0.560 Inch, 2 Digit, Common Cathode, RHDP                               | 159            | Red    |                   | 30  | 6   | 960                            |
| 3076            | 0.560 Inch, Seven Segment, 1 Digit w/Overflow and ±, Common Anode, RHDP | 160            | Red    |                   | 30  | 6   | 840                            |
| 3077            |   |                |        |                   | 0.560 Inch, Seven Segment, 1 Digit w/Overflow and ±, Common Cathode, RHDP | 30  | 6                              |
| 3078            | 0.560 Inch, Seven Segment, Common Anode, RHDP                           | 161            | Red    |                   | 30  | 6   | 480                            |
| 3079            | 0.560 Inch, Seven Segment, Common Cathode, RHDP                         | 161            | Red    |                   | 30  | 6   | 480                            |
| 3080            | 0.800 Inch, Seven Segment, Common Anode, RHDP                           | 162            | Red    |                   | 30  | 5   | 105                            |
| 3080-G          |   |                | Green  |                   | 25  | 5   | 105                            |
| 3080-Y          |   |                | Yellow |                   | 30  | 5   | 105                            |

LHDP - Left Hand Decimal Point

RHDP - Right Hand Decimal Point

See Diagrams, beginning on Page 1-163

# LED DISPLAY OUTLINES

**NTE3050**

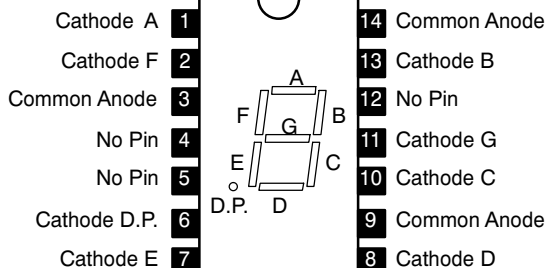

**NTE3051**

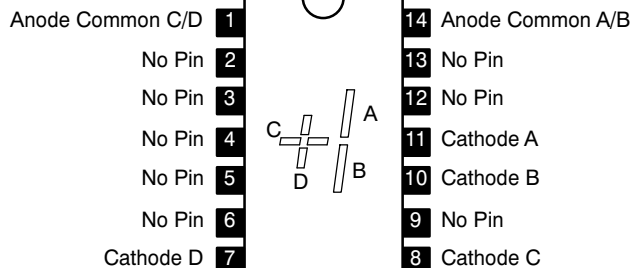

**NTE3052, NTE3053  
NTE3054, NTE3055**

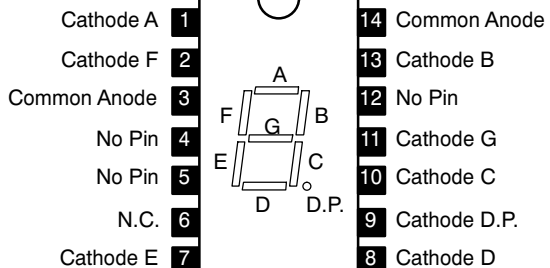

**NTE3056, NTE3058  
NTE3059, NTE3060**

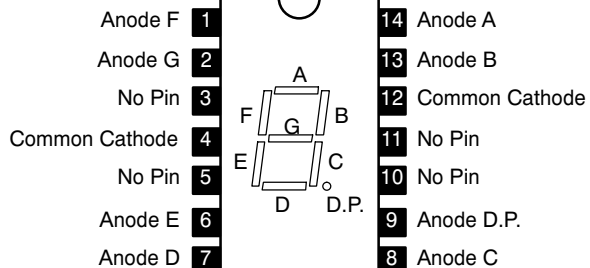

**NTE3057**

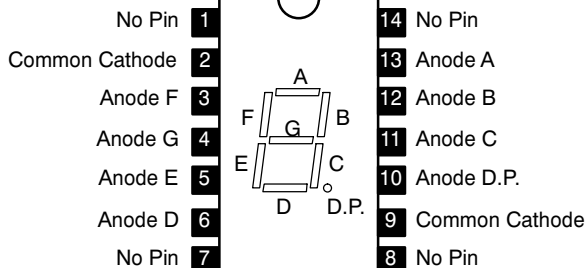

**NTE3061, NTE3062  
NTE3063, NTE3064**

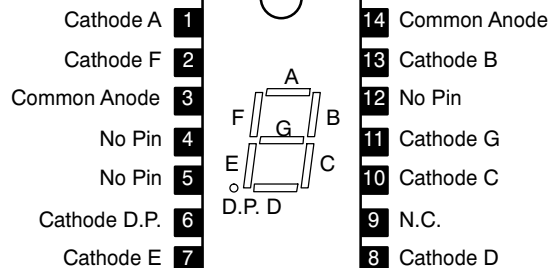

**NTE3065**

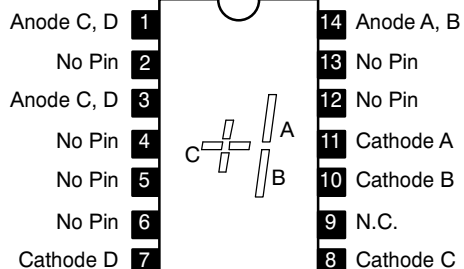

**NTE3068, NTE3070**

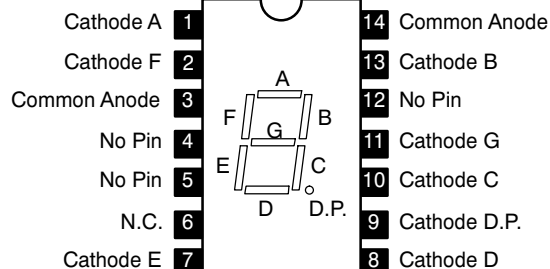

See Diagrams, beginning on Page 1-163

# LED DISPLAY OUTLINES

**NTE3069, NTE3071**

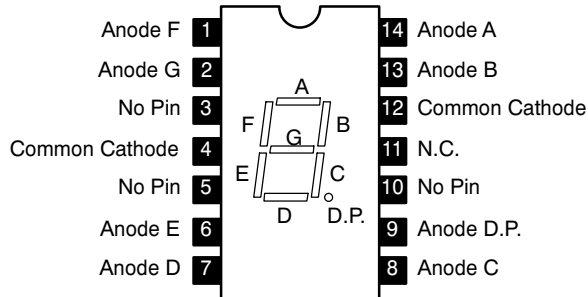

**NTE3074**

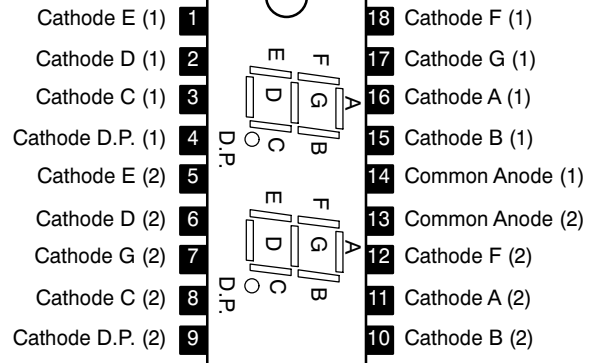

**NTE3075**

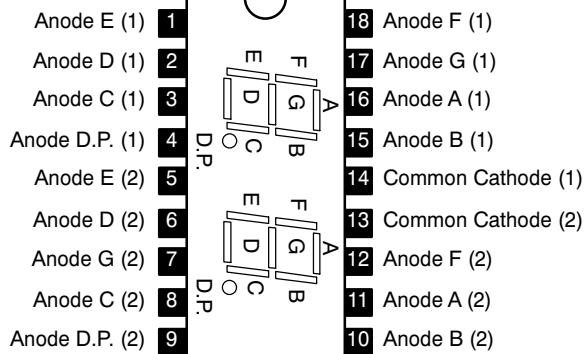

**NTE3076**

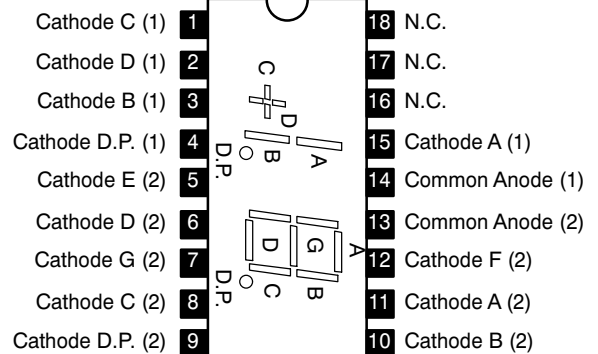

**NTE3077**

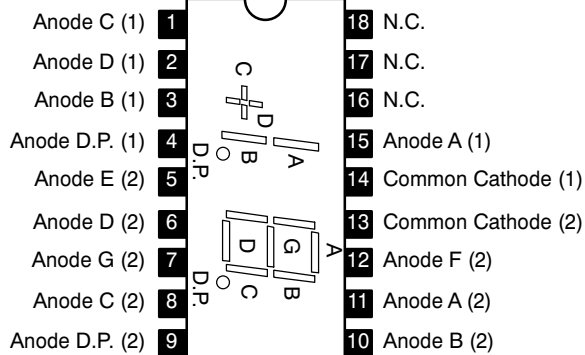

**NTE3078**

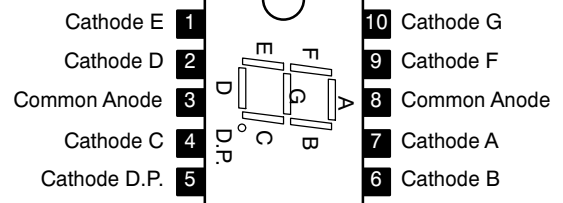

**NTE3079**

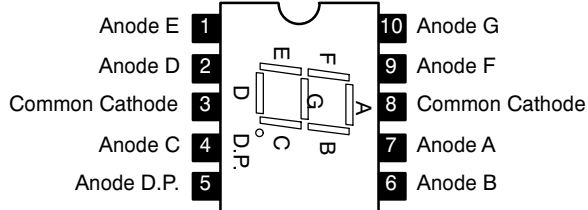

**NTE3080, NTE3080-G, NTE3080-Y**

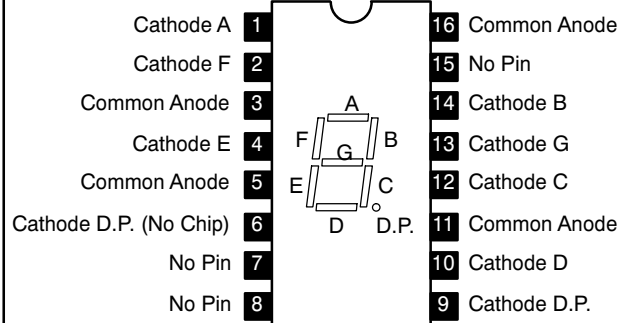

See Diagrams, beginning on Page 1-163